

Cambridge Brass  
P.O. Box 249  
140 Orion Place  
Cambridge, Ontario  
Canada N1R 5V1  
Tel: (519) 621-5520  
Fax: (519) 621-8674  
http://www.cambridgebrass.com

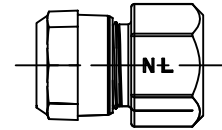

ADAPTER STYLE



MODEL NO. 117NL

CB COMPRESSION x  
FEMALE COPPER FLARE

117NL-H2P2/117NL-H3P2

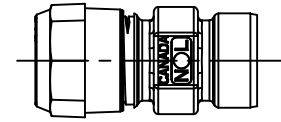

117NL-H3P1

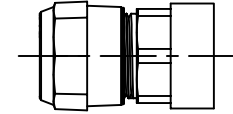

117NL-H3P3

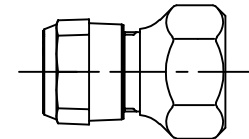

117NL-H3P4

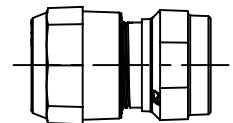

117NL-H4P4

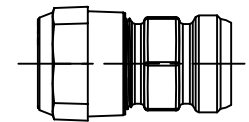

117NL-H4P3

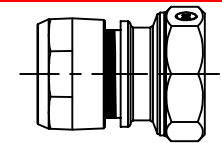

117NL-H6P6/117NL-H7P7

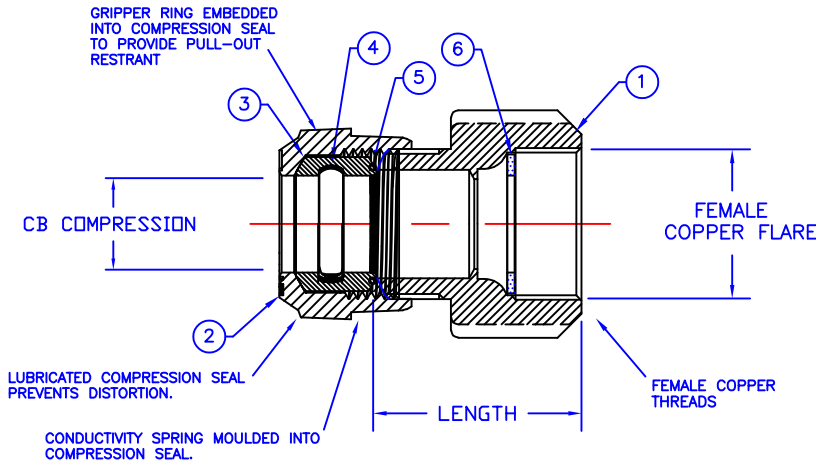

PARTS AND MATERIAL:

1. BODY: CAST BRASS, ALLOY C89833
2. COMPRESSEION NUT: CAST BRASS, ALLOY C83600
3. COMPRESSION SEAL: EPDM
4. GRIPPER: STAINLESS STEEL, ALLOY 302
5. CONDUCTOR SPRING: BRASS
6. SEALING WASHER: COPPER

FEATURES

- CONFORMS TO AWWA C800 (ASTM B584 UNS C89833 FOR BRASS PARTS IN CONTACT WITH POTABLE WATER)
- CONFORMS TO ANSI/NSF 61-8
- CONFORMS TO ANSI/NSF 372 (COMPLIANT WITH US Safe Drinking Water Act. PL 111-380)
- BODY AND NUTS PROVIDE WRENCH FLATS FOR INSTALLATION
- 300PSI WORKING PRESSURE

Cambridge Brass considers the information in this submittal form to be correct at the time of publication. Item and option availability, including specifications, are subject to change without notice.

CATALOG NO.	CB COMPRESSION	FEMALE COPPER FLARE	LENGTH	APPROX. WT. LBS.
117NL-H2P2	5/8"	5/8"	1.47"	0.65
117NL-H3P1	3/4"	1/2"	2.08"	0.71
117NL-H3P2	3/4"	5/8"	1.61"	0.70
117NL-H3P3	3/4"	3/4"	1.79"	0.70
117NL-H3P4	3/4"	1"	2.00"	0.87
117NL-H4P3	1"	3/4"	2.29"	1.20
117NL-H4P4	1"	1"	2.03"	1.25
117NL-H6P6	1 1/2"	1 1/2"	2.79"	3.20
117NL-H7P7	2"	2"	3.19"	4.25

Submitted by: